

# Edda

# SITS



# Edda

*M. Jöns* *N. Kayser*

designed by: Böttcher & Kayser



## UPHOLSTERY



fabric

## COMFORTS



STD standard



LUX lux

## COVERS



LCV loose with velcro

## SPECIAL



modular system

All elements are freestanding.

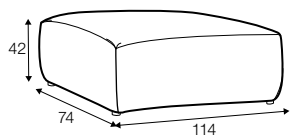

footstool 114x74

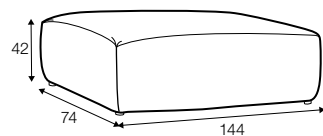

footstool 144x74

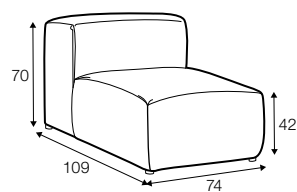

element 74x109

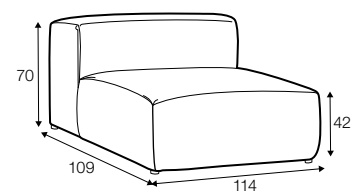

element 114x109

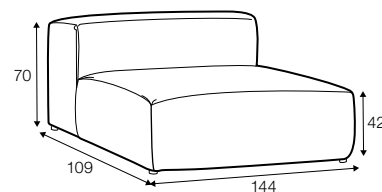

element 144x109

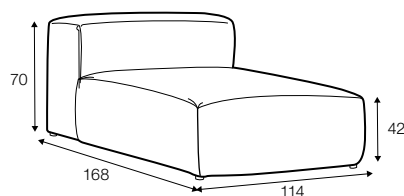

element 114x168

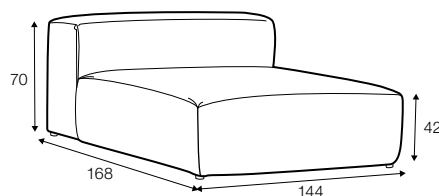

element 144x168

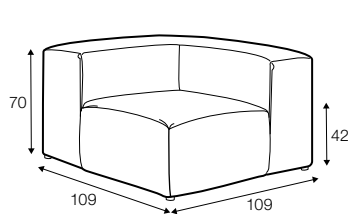

corner 90°

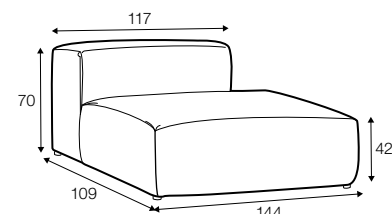

bench 144x109 right / or left

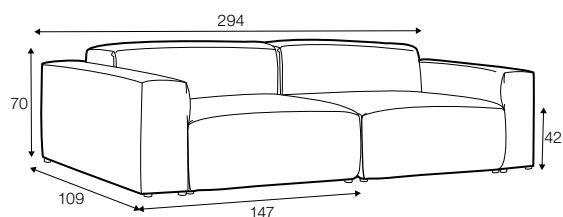

set 1

2x element 114x109 + 2x armrest 109x33

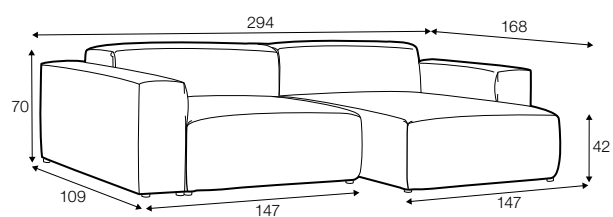

set 2

element 114x109 + element 114x168 + 2x armrest 109x33

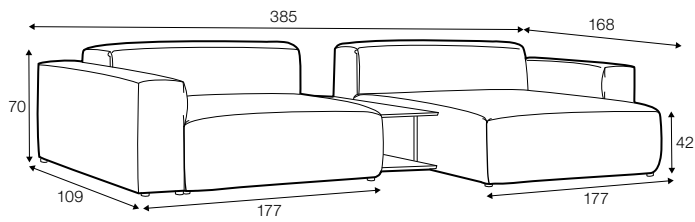

**set 3**

element 144x109 + element 144x168  
 + 2x armrest 109x33 + coffee table 104x31

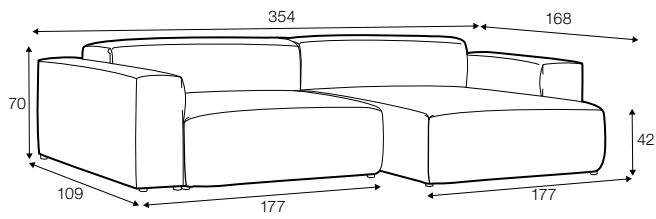

**set 4**

element 144x109 + element 144x168 + 2x armrest 109x33

**extra dimensions**

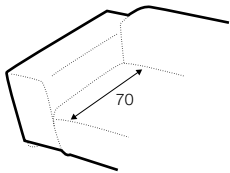

depth of seat

**accessories**

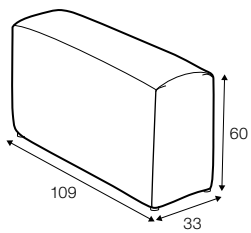

armrest 109x33

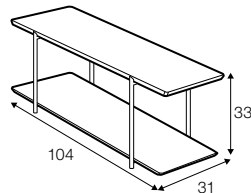

coffee table 104x31

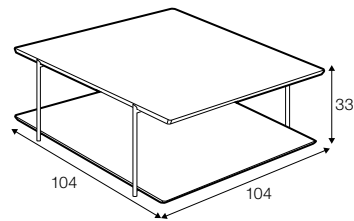

coffee table 104x104

**legs**

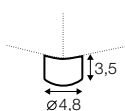

no. 173  
 wood

## available materials for top

---



wood: oak



wood: black

## available materials for frame

---



metal: black

## profile

---

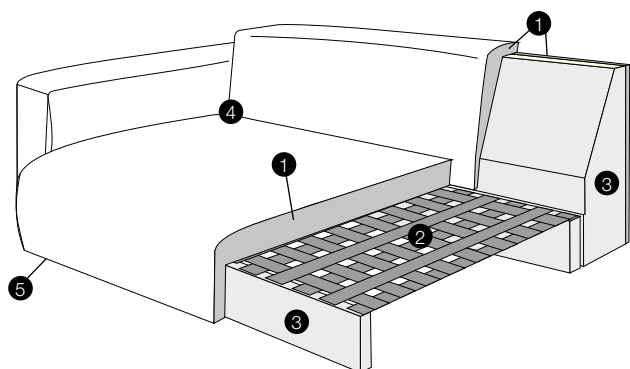

### standard

1. polyurethane foam/high resilient polyurethane foam
2. upholstery belts
3. solid wood and wood based elements
4. fabric
5. solid wood or metal legs

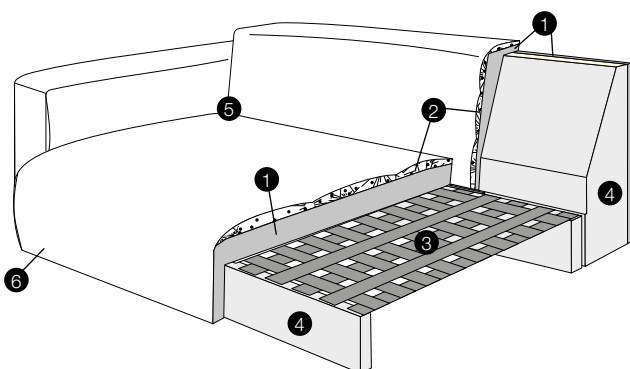

### lux

1. polyurethane foam/high resilient polyurethane foam
2. cushion chamber with mix of feather and silicone balls
3. upholstery belts
4. solid wood and wood based elements
5. fabric
6. solid wood or metal legs